

MCK0900



VEICOLI GRUPPO VW – Individuare il kit catena più indicato

PROCEDURA DI FASATURA VALVOLE

– Precisazioni sulla coppia di serraggio viti

PARAOILI IN FPM E PTFE – Istruzioni ed accorgimenti per la corretta installazione



VW GROUP VEHICLES – How to identify the most correct timing chain kit

VALVE TIMING PROCEDURE

– Clarification on screw tightening torque

FPM AND PTFE OIL SEALS – Instructions and precautions for proper installation



FAHRZEUGE DER VW-GRUPPE – Wie Erkennt man den Richtigen Steuerkettensatz?

VENTILSTEUERUNG

– Erklärung zum Schraubenanzugsmoment

FPM- UND PTFE-ÖLDICHTUNGEN – Anweisungen und Vorsichtsmassnahmen für die Ordnungsgemässe Installatio



VÉHICULES DU GROUPE VW – Comment identifier le kit chaîne de distribution le plus adapté

PROCÉDURE DE CALAGE DE LA CHAÎNE DE DISTRIBUTION

– Précision sur le couple de serrage des vis

JOINTS D'ÉTANCHÉITÉ FPM ET PTFE – Instructions et précautions pour une bonne installation



VEHÍCULOS DEL GRUPO VW – Cómo identificar el kit de cadena de distribución más adecuadote

PROCEDIMIENTO DE REGULACIÓN DE LA VÁLVULA

– Aclaración sobre el par de apriete de tornillos

FPM Y PTFE JUNTA DE ACEITE – Instrucciones y precauciones para una correcta instalación



VW GRUBU ARAÇLAR – Doğru zinciri kiti nasıl belirlenir?

SUPAP ZAMANLAMASI PROSEDÜRÜ

– Vida sikma torku ile ilgili açıklama

FPM VE PTFE YAĞ KEÇELERİ – Doğru takma yöntemine yönelik talimatlar ve önlemler

**MAGNETI
MARELLI**

PARTS & SERVICES

Veicoli gruppo VW

COME INDIVIDUARE IL KIT CATENA PIÙ INDICATO

La distribuzione a catena è ampiamente utilizzata anche su vari veicoli prodotti dal gruppo VOLKSWAGEN.

L'evidenza dimostra come tale gruppo sia solito apportare varie modifiche successive sulle medesime motorizzazioni, sostituendo alcuni componenti distribuzione.

Questo di fatto rende impegnativo identificare il corretto schema distribuzione motore e, di conseguenza, individuare il kit catena distribuzione di ricambio Magneti Marelli Parts & Services.

Al fine di ridurre al minimo la possibilità di errore nella scelta dei kit catena per la manutenzione di un veicolo appartenente al gruppo VW, consigliamo sempre di:



Controllare i **codici OE** dei principali componenti quali: catena, ingranaggi, tenditore

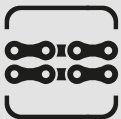

Controllare il **tipo di catena** installata (Simplex / Duplex / Morse...)



Controllare il **numero di maglie** della/e catena/e originale/i



Verificare la presenza di **informative** dedicate al veicolo/ modello stesso (es.: presenza di codici QR nella confezione)



Confrontare poi queste informazioni con quelle relative ai componenti presenti nei vari kit Magneti Marelli Parts & Services



Le istruzioni, le raccomandazioni e le informazioni contenute nella presente pubblicazione sono state formulate con la massima cura. Marelli Aftermarket Italy S.p.A., in nome e per conto delle sue affiliate/consociate, non assume responsabilità per alcun tipo di danno anche derivante da errata interpretazione delle informazioni ivi contenute.

**MAGNETI
MARELLI**

PARTS & SERVICES

MCK0900

PROCEDURA DI FASATURA VALVOLE

Case automobilistiche: **Audi, Volkswagen**Modelli: **Audi A3, Volkswagen EOS, Golf V, Golf Plus, Jetta III, Passat VI, Touran**Codice Motore: **BAG, BLF, BLG, BLP, BMY**Potenza: **1.4 FSI, 1.4 TSI, 1.6 FSI (115, 140, 170 CV)**Pignone: **Z=18/23; OE: 03C105209AF/AG**

Precauzioni generali

- Staccare sempre il cavo di massa della batteria.
- Togliere le candele di accensione per far girare più facilmente il motore.
- Girare sempre il motore nel senso normale di rotazione (salvo indicazione contraria).
- Osservare le coppie di serraggio.
- Se in dotazione: contrassegnare la posizione del sensore di posizione albero motore prima di procedere allo smontaggio.
- **NON** ruotare l'albero motore agendo sull'albero a camme o su altri pignoni.
- **NON** ruotare l'albero motore o l'albero a camme con la catena della distribuzione smontata.

Attrezzi speciali

- Comparatore a quadrante - n. VAS 6079.
- Supporto comparatore a quadrante - n. T10170.
- Attrezzo di allineamento albero a camme - n. T10171.
- Attrezzo di bloccaggio pignone albero a camme/pompa dell'olio - n. T10172.
- Attrezzo di bloccaggio albero motore - n. T10340.
- Attrezzo di bloccaggio puleggia albero motore - n. 3415.
- Perno di bloccaggio tendicatena - n. T40011.

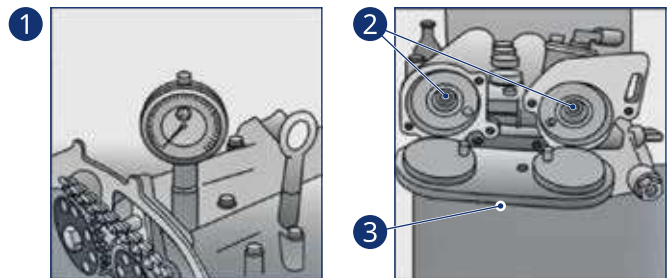

Procedure di fasatura valvole

- Per smontare/montare la catena della distribuzione è necessario:
 - Smontaggio del coperchio della distribuzione.
 - Smontaggio della coppa.

! *Contrassegnare la direzione di rotazione sulle catene.*

- Montare il comparatore e il supporto nel foro candela del cilindro n. 1. Accertarsi che il motore si trovi al PMS del cilindro n. 1 **1**.

- Accertarsi che le tacche di fasatura sugli alberi a camme siano allineate come illustrato **2**.

In caso contrario, ruotare l'albero motore di 360°.

- Montare l'attrezzo di allineamento alberi a camme **3**.

! *Se l'attrezzo di allineamento alberi a camme non può essere inserito, la fasatura delle valvole non è corretta.*

- Comprimerne il tendicatena e bloccarlo con il perno di bloccaggio **4**.
- Smontare i pignoni alberi a camme e la catena.
- Allineare gli alberi a camme. Utilizzare l'attrezzo speciale **3**.

- Montare i pignoni alberi a camme e la catena della distribuzione.
 - **Motori con fasatura valvole variabile:**
Installare un nuovo bullone. Serrare il bullone del dispositivo di registrazione albero a camme di aspirazione **5**. Coppia di serraggio: 40 Nm + 90°.

! *Il bullone del pignone albero a camme di aspirazione ha una filettatura sinistrorsa.*

• **Motori senza fasatura valvole variabile:**

Serrare il bullone del pignone albero a camme di aspirazione **6**. Coppia di serraggio: 50 Nm + 90°.

- Serrare il bullone del pignone albero a camme di scarico. Coppia di serraggio: 50 Nm + 90°.
- Serrare il bullone della puleggia albero motore. Coppia di serraggio **7**:
 - A = 150 Nm + 180°
 - B = 90 Nm + 90°.

! *Il bullone della puleggia albero motore e il bullone di ogni pignone albero a camme DEVONO essere utilizzati soltanto una volta.*

- Smontare l'attrezzo di allineamento alberi a camme. Ruotare l'albero motore in senso orario di due giri.
- Controllare la fasatura delle valvole **3**.

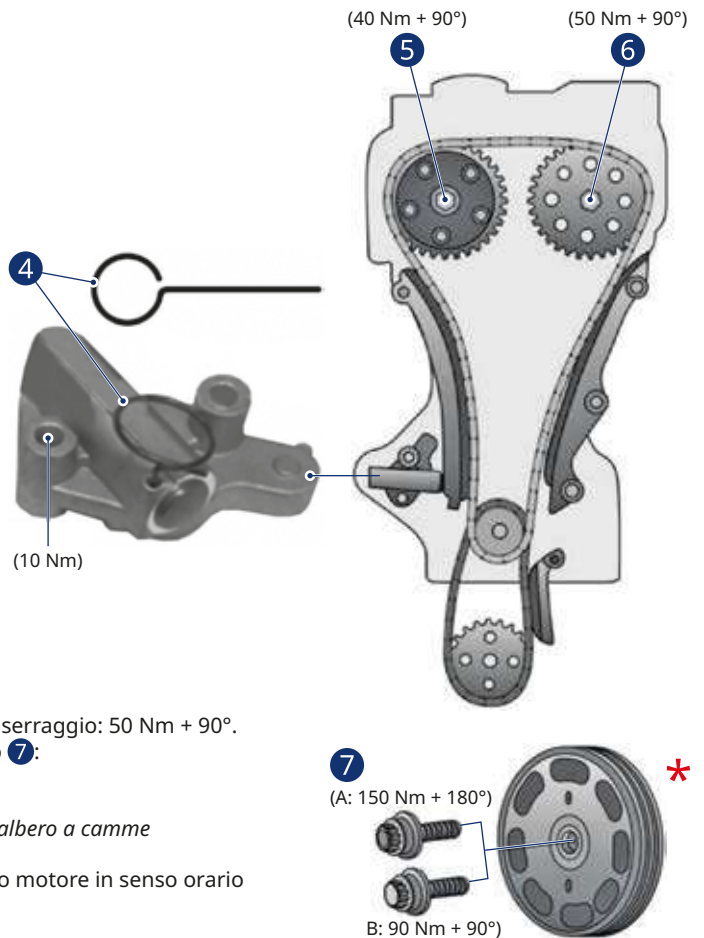

! Il tendicatena contenuto in questo kit è caricato a molla e potrebbe provocare danni se maneggiato non correttamente. **NON** rimuovere il perno finché non è completamente installato ed assicurarsi sempre che il pistone sia rivolto lontano da voi e da chiunque altro in un raggio di 20 metri.

Le istruzioni, le raccomandazioni e le informazioni contenute nella presente pubblicazione sono state formulate con la massima cura. Magneti Marelli Aftermarket Italy S.p.A., in nome e per conto delle sue affiliate/consociate, non assume responsabilità per alcun tipo di danno anche derivante da errata interpretazione delle informazioni ivi contenute.

**MAGNETI
MARELLI**

PARTS & SERVICES

* PRECISAZIONI SULLA COPPIA DI SERRAGGIO VITI

Nella scheda informativa è riportata la seguente informazione:

- Serrare il bullone della puleggia albero motore.
Coppia di serraggio ⑦:

- A = 150 Nm + 180°
- B = 90 Nm + 90°.

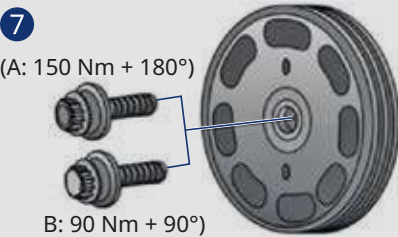

Due coppie di serraggio per un'unica vite. Quale delle due?

A

Se sul veicolo è installata una **vite a dodecaedro**, combinata, con testa perforata, classe di resistenza/categoria di 10.9, dimensioni M14x1,5x100, codice OE: N91048601 simile a quella riportata nelle foto:



La coppia massima di serraggio deve essere fissata a **150 Nm + 180°** (Caso A)

B

Se invece fosse presente una vite differente da quella mostrata in foto, "**senza testa della vite**" la coppia massima di serraggio deve essere fissata a **90 Nm + 90°** (Caso B)

**MAGNETI
MARELLI**

PARTS & SERVICES

Paraoli in FPM e PTFE

ISTRUZIONI ED ACCORGIMENTI PER LA CORRETTA INSTALLAZIONE

All'interno dei kit catena Magneti Marelli Parts & Services, si possono trovare due tipologie di paraoli: **paraoli in FPM** (Gomma-Caucciù Fluorata) e **paraoli in PTFE** (Politetrafluoretilene).

Tali paraoli differiscono tra loro, oltre che per il materiale costruttivo, anche per le modalità e gli accorgimenti necessari per la loro corretta installazione.

Paraoli in FPM (gomma-caucciù fluorata)

Caratteristiche

- Sono considerati i paraoli "tradizionali".
- Creano una barriera fisica tra l'ambiente interno a contatto con il fluido e l'ambiente esterno.
- Presentano al loro interno una molla in metallo che preme sul labbro interno di tenuta per tutta la circonferenza del paraolio; in questo modo si migliora la tenuta in quanto viene esercitata una elevata pressione.

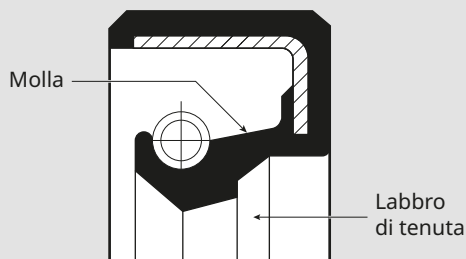

Istruzioni di montaggio

- Verificare i parametri costruttivi (dimensioni e verso di rotazione) e la tipologia di materiale del paraolio da sostituire.
- Rimuovere impurità e sporcizia da tutte le superfici metalliche che entrano a contatto con il paraolio.
- **Non applicare grasso e/o lubrificanti sulla superficie esterna del paraolio e sulla sede.** Se queste superfici vengono contaminate la tenuta esterna viene compromessa al momento del montaggio.
- **Lubrificare con grasso solamente il labbro di tenuta interno del paraolio e la superficie di scorrimento sull'albero.**
- Procedere con il montaggio nella sede con gli appositi utensili. I parametri costruttivi devono essere rivolti verso l'esterno.



La tenuta del paraolio è quasi immediata e il motore può essere acceso anche dopo dieci minuti.

Paraolio in PTFE (politetrafluoretilene)

Caratteristiche

Questi paraoli, nonostante l'assenza della molla di metallo interna, presentano le seguenti peculiarità:

- Maggiore superficie di tenuta a contatto con il metallo che va a migliorare la tenuta.
- Migliore resistenza meccanica alle sollecitazioni anche ad alti regimi di rotazione.
- Migliore resistenza chimica ai lubrificanti con additivi.
- Migliore resistenza alle alte temperature.
- Significativa riduzione delle perdite per attrito.

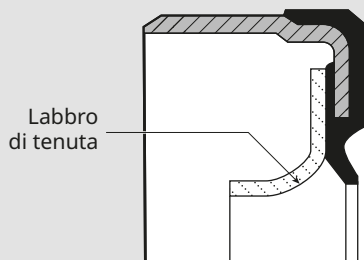

Istruzioni di montaggio



Il montaggio di questi paraoli è differente rispetto l'installazione di un paraolio "tradizionale" in FPM; il labbro interno è protetto da un manicotto in plastica per il mantenimento della forma geometrica e la perfetta adesione all'albero. **Il manicotto deve essere rimosso solo in fase di montaggio del paraolio.**

- Sono necessari degli appositi utensili per il montaggio del paraolio. **Evitare in ogni modo di danneggiare il labbro interno dello stesso.**
- Il montaggio del paraolio in PTFE avviene a secco senza grassi e/o lubrificanti. **Questo paraolio non deve essere mai lubrificato.**
- Verificare i parametri costruttivi (dimensioni e verso di rotazione) e la tipologia di materiale del paraolio da sostituire.
- Rimuovere impurità e sporcizia da tutte le superfici metalliche che entrano a contatto con il paraolio.
- Verificare la superficie dell'albero: non devono essere presenti solchi o altri danni. Eventuali non conformità vanno rimosse.
- Appoggiare l'estremità scanalata del manicotto sull'albero. Inserire il paraolio nella sede facendolo scorrere sul manicotto. Una volta che il paraolio è stato posizionato nella sua sede rimuovere il manicotto.



La tenuta del labbro del paraolio in PTFE non è istantanea. Prima di accendere il motore attendere fino a quattro ore dal montaggio per consentire l'adattamento all'albero e la migliore tenuta del labbro.

Le istruzioni, le raccomandazioni e le informazioni contenute nella presente pubblicazione sono state formulate con la massima cura. Marelli Aftermarket Italy S.p.A., in nome e per conto delle sue affiliate/consociate, non assume responsabilità per alcun tipo di danno anche derivante da errata interpretazione delle informazioni ivi contenute.



VW group vehicles

HOW TO IDENTIFY THE MOST CORRECT TIMING CHAIN KIT

Timing chain distribution is widely applied also on various VOLKSWAGEN group models.

Evidence shows that this group is used to make various successive modifications to the same engines, changing some distribution components.

This makes difficult to identify the correct engine timing distribution scheme and so the identification of the right Magneti Marelli Parts & Services timing chain kit to be used.

To minimize the chances of mistake in the choice of proper timing chain kit for the maintenance of a VW group vehicle, we suggest to:



Check the **OE codes** of timing main components such as: chains, tensioners, gears...

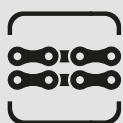

Check the **type of the installed chain** (Simplex / Duplex / Morse...)



Check OE **chains' links number**



Check and verify the presence of any **Technical bulletin** related to the vehicle/model (ex.: QR code inside MM timing chain kit box)



Verify all the afore mentioned information with the ones available and connected to the components of a specific Magneti Marelli Parts & Services timing chain kit



The instructions, the recommendations and the information contained in this publication have been prepared with the utmost attention. Marelli Aftermarket Italy S.p.A., in the name and on behalf of its affiliates/subsidiaries, does not assume responsibility for any type of damage even deriving from incorrect interpretation of the information therein contained.



MCK0900

VALVE TIMING PROCEDURE

Car brands: **Audi, Volkswagen**

Models: **Audi A3, Volkswagen EOS, Golf V, Golf Plus, Jetta III, Passat VI, Touran**

Engine code: **BAG, BLF, BLG, BLP, BMJ**

Power: **1.4 FSI, 1.4 TSI, 1.6 FSI (115, 140, 170 CV)**

Pignon: **Z=18/23; OE: 03C105209AF/AG**

General precautions

- Always disconnect the ground cable from the battery.
- Remove the spark plugs in order to allow the engine to turn more freely.
- Always turn the engine in the normal direction of rotation (unless specifically instructed otherwise).
- Observe tightening torques.
- If fitted: note the position of the engine shaft position sensor before dismantling.
- **DO NOT** turn the engine shaft by turning the camshaft or other pinions.
- **DO NOT** turn the engine shaft or camshaft with the timing chain removed.

Valve timing procedure

- To dismantle/fit the timing chain it is necessary:
 - To remove the timing cover.
 - To remove the cup.
- ! **Mark the direction of rotation on the chains.**
- Fit the gauge and its support into the spark plug hole for cylinder n. 1. Make sure that the engine is at the TDC of cylinder n. 1 **1**.
- Make sure that the timing marks on the camshaft are aligned as shown **2**. Otherwise, turn the engine shaft 360°.
- Fit the camshaft alignment tool **3**.
- ! **If the camshaft alignment tool cannot be inserted, valve timing is not correct.**
- Press the chain tensioner and block it with the blocking pin **4**.
- Dismantle the camshaft pinion and the chain.
- Align the camshafts. Use the special tool **3**.
- Fit the camshaft pinion and the timing chain.
 - **Engines with variable valve timing:**
Fit a new bolt. Tighten the bolt for the intake camshaft adjustment device **5**. Tightening torque: 40 Nm + 90°.
 - ! **The intake camshaft pinion bolt is reverse threaded.**
 - **Engines without variable valve timing:**
Tighten the intake camshaft pinion bolt **6**. Tightening torque: 50 Nm + 90°.
- Tighten the exhaust camshaft pinion bolt. Tightening torque: 50 Nm + 90°.
- Tighten the engine shaft pulley bolt. Tightening torque **7**:
 - A = 150 Nm + 180°
 - B = 90 Nm + 90°.
- ! **The engine shaft pulley bolt and all camshaft pinion bolts MUST be used once only.**
- Dismantle the camshaft alignment tool. Turn the engine shaft clockwise for two turns.
- Check valve timing **3**.

Special equipment

- Display gauge – n. VAS 6079.
- Display gauge support – n. T10170.
- Camshaft alignment tool – n. T10171.
- Camshaft pinion-oil pump blocking tool – n. T10172.
- Engine shaft blocking tool – n. T10340.
- Engine shaft pulley blocking tool – n. 3415.
- Chain tensioner blocking pin – n. T40011.

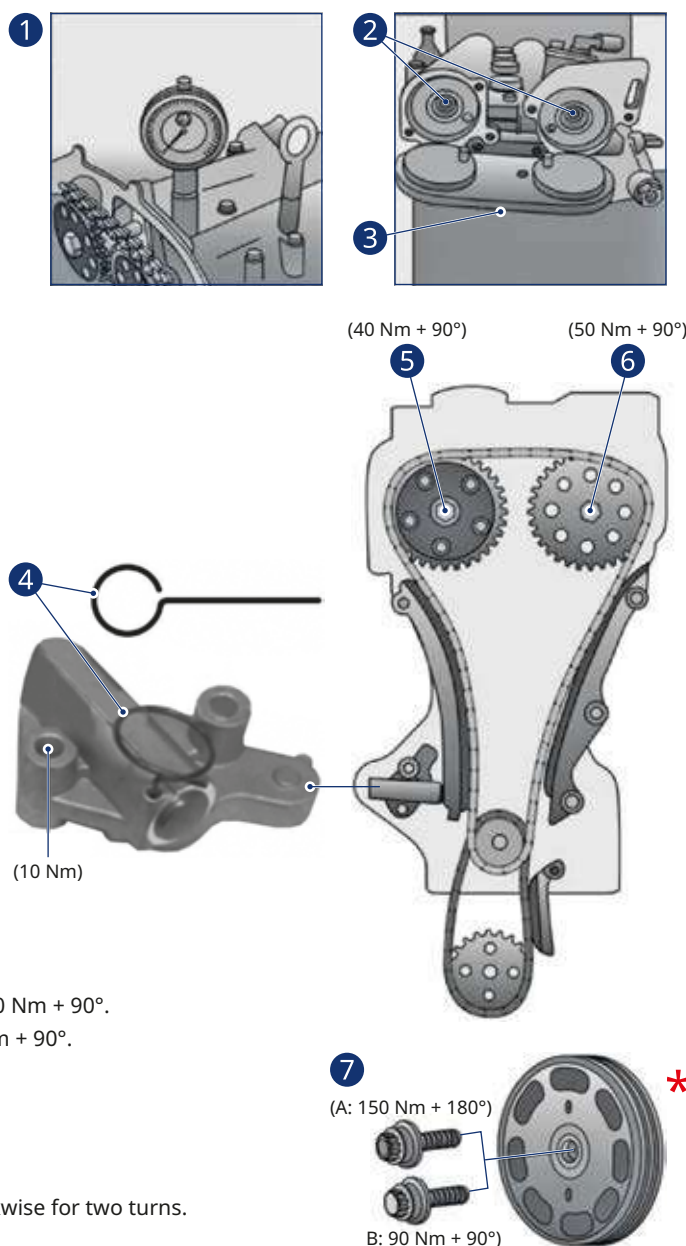

! The chain tensioner contained in this kit is spring-loaded and may cause damage if not handled correctly. **DO NOT** remove the pin until it is completely installed, and always ensure that the piston is pointing away from you or anyone else within a range of 20 metres.

The instructions, the recommendations and the information contained in this publication have been prepared with the utmost attention. Magneti Marelli Aftermarket Italy S.p.A., in the name and on behalf of its affiliates/subsidiaries, does not assume responsibility for any type of damage even deriving from incorrect interpretation of the information therein contained.

* CLARIFICATION ON SCREW TIGHTENING TORQUE

On the Technical bulletin is showed the following information:

- Tighten the engine shaft pulley bolt.
Tightening torque ⑦:

- A = 150 Nm + 180°
- B = 90 Nm + 90°.

⑦
(A: 150 Nm + 180°)
B: 90 Nm + 90°

Two tightening torques for a single screw. Which one?

A

If on the vehicle is installed a **combined dodecahedron screw**, with bore headed, resistance/category 10.9, dimensions M14x1,5x100, OE n.: N91048601 like the one showed here below:



Maximum tightening torque must be fixed to: **150 Nm + 180°** (Case A)

B

If on the vehicle is installed a different screw **“without screw head”**, maximum tightening torque must be fixed to **90 Nm + 90°** (Case B)

**MAGNETI
MARELLI**

PARTS & SERVICES

FPM and PTFE oil seals

INSTRUCTIONS AND PRECAUTIONS FOR PROPER INSTALLATION

Magneti Marelli Parts & Services chain kits include two types of oil seal, one in **FPM** (fluorine rubber) and the other in **PTFE** (Polytetrafluoroethylene).

The two oil seals differ not only in terms of the material they are made of, but also in terms of the method for correct installation and relative precautions.

FPM (fluorine rubber) oil seals

Characteristics

- These oil seals are considered to be the "traditional" type.
- They create a physical barrier between the internal environment, in contact with the fluid, and the external environment.
- They have a metal spring inside that applies pressure to the entire circumference of the inner oil seal lip, thus improving tightness.

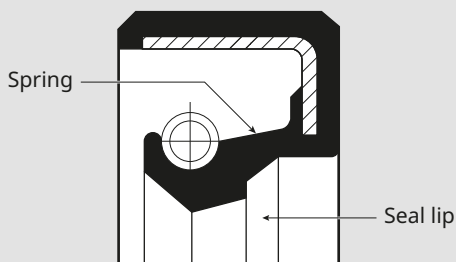

Installation instructions

- Check the seal data (size and direction of rotation) and the type of oil seal material to be replaced.
- Remove any dirt and debris from all metal surfaces that come into contact with the oil seal.
- **Do not apply grease or lubricants to the outer surface of the oil seal or the seal housing.** If these surfaces are contaminated, external sealing will be compromised as soon as the seal is fitted.
- **Apply grease to the inner sealing lip of the oil seal and the sliding surface on the shaft only.**
- Fit the seal into position with the appropriate tools. The side showing the seal data must be facing outwards.



The oil seal is effective almost immediately and the engine can be started after ten minutes.

PTFE (polytetrafluoroethylene) oil seal

Characteristics

Despite the absence of an internal metal spring, these oil seals have the following characteristics:

- Larger sealing surface in contact with the metal, providing increased tightness.
- Improved mechanical resistance to stress even at high rotation speeds.
- Improved chemical resistance to lubricants with additives.
- Improved resistance to high temperatures.
- Significant reduction in leaks due to friction.

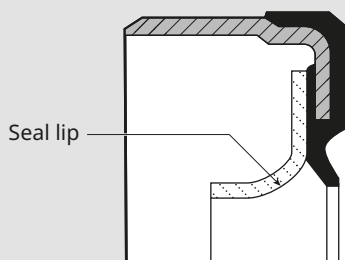

Installation instructions



These oil seals are installed differently from "traditional" oil seals in FPM; the inner lip is protected by a plastic sleeve that maintains the shape of the seal and ensures perfect adhesion to the shaft. **The sleeve must only be removed when installing the oil seal.**

- Specific tools are required to install the oil seal. **Do not damage the inner lip of the seal in any way.**
- The PTFE oil seal is to be installed dry, without the use of grease and/or lubricants. **This oil seal must never be lubricated.**
- Check the seal data (size and direction of rotation) and the type of oil seal material to be replaced.
- Remove any dirt and debris from all metal surfaces that come into contact with the oil seal.
- Check the surface of the shaft, ensuring that it is free of grooves or other damage. Any irregularities must be removed.
- Place the grooved end of the sleeve on the shaft. Insert the oil seal into its housing by sliding it along the sleeve. Once the oil seal has been positioned in its housing, remove the sleeve.



The PTFE oil seal is not immediately effective. Allow up to four hours after fitting before starting the engine to allow the seal to adapt to the shaft and achieve full tightness.

The instructions, the recommendations and the information contained in this publication have been prepared with the utmost attention. Magneti Marelli Aftermarket Italy S.p.A., in the name and on behalf of its affiliates/subsidiaries, does not assume responsibility for any type of damage even deriving from incorrect interpretation of the information therein contained.



Fahrzeuge der VW-Gruppe

WIE ERKENNT MAN DEN RICHTIGEN STEUERKETTENSATZ?

Der Einsatz von Steuerketten ist bei verschiedenen Modellen der VOLKSWAGEN-Gruppe weit verbreitet.

Es ist erwiesen, dass die VAG verschiedene aufeinanderfolgende Änderungen an denselben Motoren vornimmt und dabei auch einige Komponenten verändert.

Dies erschwert die Identifizierung der korrekten Motorsteuerung und damit auch die Identifizierung des richtigen Steuerkettensatzes von Magneti Marelli Parts & Services, welcher verwendet werden sollte.

Um die Wahrscheinlichkeit eines Fehlers bei der Wahl des richtigen Steuerkettensatzes für die Wartung eines Fahrzeugs der VW-Gruppe zu minimieren, empfehlen wir Folgendes:



Überprüfen Sie die **OE-Codes** der Hauptkomponenten der Steuerung, wie z.B.: Ketten, Spanner, Zahnräder etc.

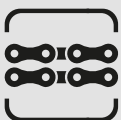

Überprüfen Sie den **Typ der installierten Kette** (Simplex / Duplex / Silent...)

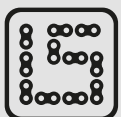

Überprüfen Sie die **Anzahl der Glieder** der Originalkette(n)



Überprüfen Sie das Vorhandensein eines **technischen Bulletins**, das sich auf das Fahrzeug/Modell bezieht (z. B.: QR-Code in der Schachtel des MM-Steuerkettensatzes)



Überprüfen Sie alle oben genannten Informationen mit den verfügbaren Informationen, die mit den Komponenten eines bestimmten Magneti Marelli Parts & Services Steuerkettensatzes verbunden sind





MCK0900

VENTILSTEUERUNG

Marken: **Audi, Volkswagen**
 Modelle: **Audi A3, Volkswagen EOS, Golf V, Golf Plus, Jetta III, Passat VI, Touran**
 Motorcode: **BAG, BLF, BLG, BLP, BMJ**
 Leistung: **1.4 FSI, 1.4 TSI, 1.6 FSI (115, 140, 170 PS)**
 Ritzel: **Z=18/23; OE: 03C105209AF/AG**

Allgemeine Vorsichtsmaßnahmen

- Klemmen Sie immer das Massekabel von der Batterie ab.
- Entfernen Sie die Zündkerzen, damit sich der Motor freier drehen kann.
- Drehen Sie den Motor immer in der normalen Drehrichtung (wenn nicht ausdrücklich anders vorgeschrieben).
- Beachten Sie die Anzugsdrehmomente.
- Falls vorhanden: Notieren Sie die Position des Kurbelwellensensors vor der Demontage notieren.
- Drehen Sie die Motorwelle **NICHT** durch Drehen der Nockenwelle oder andere Ritzel.
- Drehen Sie die Motorwelle oder Nockenwelle **NICHT**, wenn die Steuerkette entfernt wurde.

Die Ventilsteuerung

- Um die Steuerkette zu demontieren/einzubauen, ist es notwendig:
 - Den Steuergehäusedeckel zu entfernen.
 - Die Abdeckung zu entfernen.

! Markieren Sie die Laufrichtung an den Ketten!

- Montieren Sie die Lehre und ihre Halterung in die Zündkerzenbohrung von Zylinder Nr. 1. Stellen Sie sicher, dass der Motor am Totpunkt des Zylinder Nr. 1 steht **1**.
- Stellen Sie sicher, dass die Steuermarkierungen an der Nockenwelle wie beschrieben ausgerichtet sind **2**. Andernfalls drehen Sie die Motorwelle um 360°.

- Montieren Sie das Nockenwellen-Ausrichtungswerkzeug **3**.
! Wenn sich das Nockenwellen-Ausrichtungswerkzeug nicht einsetzen lässt, ist die Ventilsteuerung nicht korrekt eingestellt!

- Halten Sie den Kettenspanner und blockieren Sie ihn mit dem Blockierstift **4**.
- Demontieren Sie das Nockenwellenritzel und die Kette.
- Richten Sie die Nockenwellen aus. Verwenden Sie das Spezialwerkzeug **3**.
- Montieren Sie das Nockenwellenritzel und die Steuerkette.

- **Für Motoren mit variabler Ventilsteuerung:**
 Montieren Sie eine neue Schraube. Ziehen Sie die Schraube für die Einlassnockenwellen-Verstellvorrichtung an **5**.
 Anzugsdrehmoment: 40 Nm + 90°.

! Die Schraube für das Einlassnockenwellenritzel hat ein Gegengewinde!

- **Für Motoren ohne variable Ventilsteuerung:**
 Ziehen Sie die Einlassnockenwellen-Ritzelschraube an **6**. Anzugsdrehmoment: 50 Nm + 90°.

- Ziehen Sie die Auslassnockenwellen-Ritzelschraube an. Anzugsdrehmoment: 50 Nm + 90°.
- Ziehen Sie die Schraube des Kurbelwellenrads an **7**. Anzugsdrehmoment:
 - A = 150 Nm + 180°
 - B = 90 Nm + 90°.

! Die Schraube der für das Kurbelwellenrad und alle Schrauben des Nockenwellenritzels **DÜRFEN** nur einmal verwendet werden!

- Demontieren Sie das Nockenwellen-Ausrichtwerkzeug. Drehen Sie die Motorwelle zwei Umdrehungen lang im Uhrzeigersinn.
- Prüfen Sie die Ventilsteuerung **3**.

Spezialwerkzeug

- Anzeigergerät – Nr. VAS 6079.
- Halterung für Anzeigergerät – Nr. T10170.
- Werkzeug zum Ausrichten der Nockenwelle – Nr. T10171.
- Nockenwellenritzel-Ölpumpen-Blockierwerkzeug – Nr. T10172.
- Werkzeug zur Blockierung der Motorwelle – Nr. T10340.
- Werkzeug zum Blockieren der Kurbelwellenscheibe – Nr. 3415.
- Blockierstift für Kettenspanner – Nr. T40011.

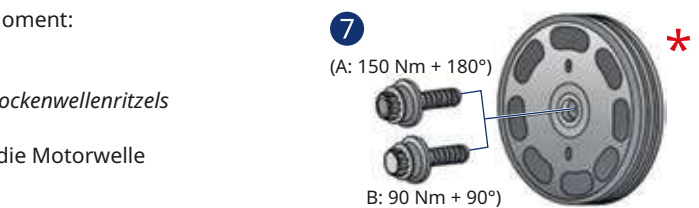
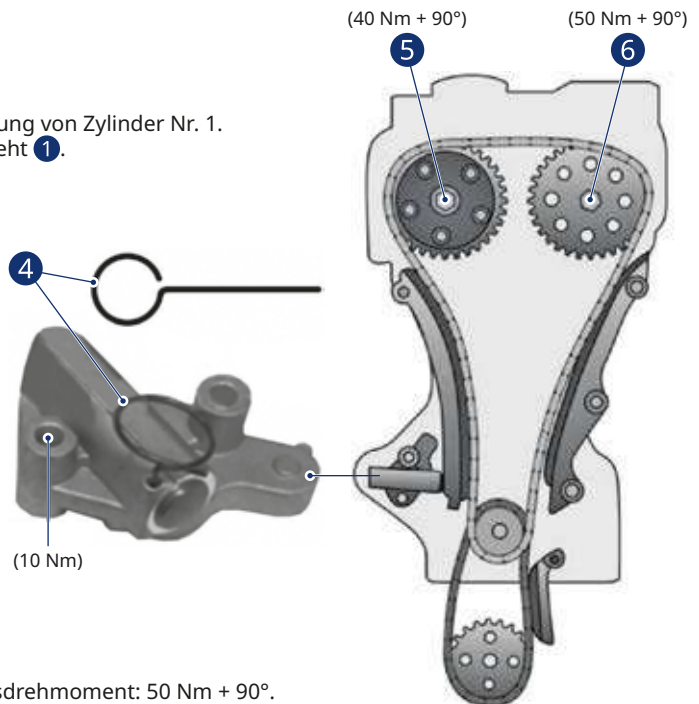
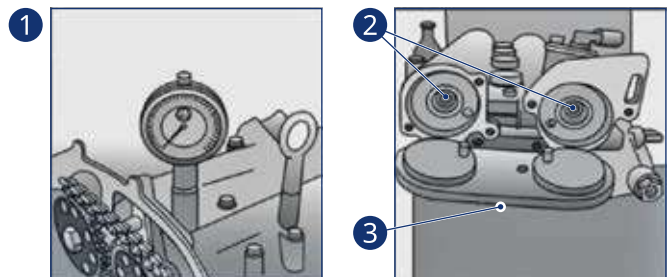

! Der in diesem Kit enthaltene Kettenspanner ist federbelastet und kann bei unsachgemäßer Handhabung Schäden verursachen. Entfernen Sie den Bolzen **NICHT**, bevor er vollständig installiert ist, und stellen Sie immer sicher, dass der Kolben von Ihnen oder anderen Personen in einem Umkreis von 20 Metern weg zeigt.

Die in dieser Publikation enthaltenen Anweisungen, Empfehlungen und Informationen wurden mit größter Sorgfalt erstellt. Marelli Aftermarket Italy S.p.A. übernimmt im Namen und im Auftrag ihrer Tochtergesellschaften keine Verantwortung für Schäden jeglicher Art, die sich auch aus einer falschen Auslegung der darin enthaltenen Informationen ergeben.

* ERKLÄRUNGEN ZUM SCHRAUBENANZUGSMOMENT

Auf dem Technischen Merkblatt wird die folgende Information angezeigt:

- Ziehen Sie die Schraube der Kurbelwellenscheibe an **7**.
Anzugsdrehmoment:

- A = 150 Nm + 180°
- B = 90 Nm + 90°.

Zwei Anzugsdrehmomente für eine einzige Schraube. Wann nehme ich was?

A

Wenn am Fahrzeug eine **kombinierte Zwölfkantschraube** installiert ist, mit Kopfbohrung, Widerstand/Kategorie 10.9, Abmessungen M14x1,5x100, OE-Nr.: N91048601 – dann wie hier unten gezeigt:



Das maximale Anzugsdrehmoment muss wie folgt festgelegt werden: **150 Nm + 180°** (Fall A)

B

Wenn am Fahrzeug eine andere Schraube „**ohne Schraubenkopf**“ montiert ist, muss das maximale Anzugsdrehmoment auf **90 Nm + 90°** festgelegt werden (Fall B).

**MAGNETI
MARELLI**

PARTS & SERVICES

FPM- und PTFE-Öldichtungen

ANWEISUNGEN UND VORSICHTSMASSNAHMEN FÜR DIE ORDNUNGSGEMÄSSE INSTALLATION

Die Kettensätze von Magneti Marelli Parts & Services enthalten zwei Arten von Öldichtungen, zum einen **FPM** (Fluorkautschuk) und zum anderen **PTFE** (Polytetrafluorethylen).

Die beiden Öldichtungen unterscheiden sich nicht nur in Bezug auf das Material, aus dem sie hergestellt sind, sondern auch im Bezug auf die Methode der korrekten Installation und der entsprechenden Vorsichtsmaßnahmen.

FPM (Fluorkautschuk) Öldichtungen

Eigenschaften

- Diese Wellendichtringe gelten als der „traditionellen“ Typ.
- Sie bilden eine physikalische Barriere zwischen der inneren Komponenten, die in Kontakt mit der Flüssigkeit stehen und der äußeren Komponenten.
- Im Inneren befindet sich eine Metallfeder, die Druck auf den gesamten Umfang der inneren Öldichtlippe ausübt und so die Dichtigkeit verbessert.

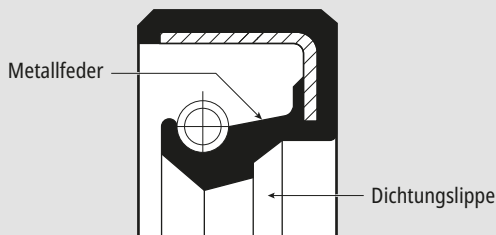

Einbauhinweise

- Prüfen Sie die Dichtungsdaten (Größe und Drehrichtung) und den Typ des Öl Dichtungsmaterials, das ersetzt werden soll.
- Entfernen Sie Schmutz und Ablagerungen von allen Metallflächen, die mit dem Wellendichtring in Berührung kommen.
- **Tragen Sie keine Fette oder Schmiermittel auf die Außenfläche der Öldichtung oder des Dichtungsgehäuses.** Wenn diese Oberflächen verunreinigt sind, wird die äußere Abdichtung beeinträchtigt, sobald die Dichtung montiert ist.
- **Tragen Sie Fett nur auf die innere Dichtlippe des Wellendichtrings und die Gleitfläche der Welle.**
- Montieren Sie den Dichtring mit den entsprechenden Werkzeugen. Die Seite mit den Dichtungsdaten muss nach außen zeigen.



Der Wellendichtring ist nach Installation schnell einsatzbereit und somit kann der Motor nach Zehn Minuten gestartet werden.

PTFE (Polytetrafluorethylen) Wellendichtring

Merkmale

Trotz des Fehlens einer inneren Metallfeder haben diese Wellendichtringe folgende Eigenschaften:

- Größere Dichtfläche in Kontakt mit dem Metall, dadurch erhöhte Dichtigkeit.
- Verbesserte mechanische Belastbarkeit auch bei hohen Drehzahlen.
- Verbesserte chemische Beständigkeit gegen Schmierstoffe mit Additiven.
- Verbesserte Beständigkeit gegen hohe Temperaturen.
- Deutliche Reduzierung von Undichtigkeiten aufgrund von Reibung.

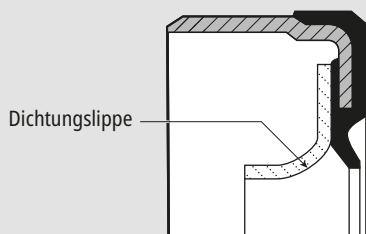

Einbauhinweise



Diese Wellendichtringe werden anders eingebaut als „herkömmliche“ Wellendichtringe aus FPM; die innere Lippe ist durch eine Kunststoffhülse geschützt, die die Form des Dichtrings beibehält und eine perfekte Haftung auf der Welle gewährleistet. **Die Hülse darf erst bei der Montage des Wellendichtrings entfernt werden.**

- Für die Montage des Wellendichtrings sind spezielle Werkzeuge erforderlich. **Beschädigen Sie nicht die Innenlippe des Dichtrings.**
- Der PTFE-Öldichtring ist trocken zu installieren, ohne Verwendung von Fett und/oder Schmiermitteln. **Dieser Wellendichtring darf niemals geschmiert werden.**
- Überprüfen Sie die Dichtungsdaten (Größe und Drehrichtung) und den Typ des zu ersetzenden Dichtungsmaterials.
- Entfernen Sie Schmutz und Ablagerungen von allen Metallflächen, die mit dem Wellendichtring in Kontakt kommen.
- Prüfen Sie die Oberfläche der Welle und stellen Sie sicher, dass sie frei von Rillen oder andere Beschädigungen sind. Alle Unebenheiten müssen beseitigt werden.
- Setzen Sie das gerillte Ende der Hülse auf die Welle. Setzen Sie den Wellendichtring in das Gehäuse ein, indem Sie ihn entlang der Hülse schieben. Sobald der Wellendichtring in seinem Gehäuse sitzt, entfernen Sie die Hülse.



Der PTFE-Öldichtring ist nicht sofort einsatzbereit. Warten Sie bis zu vier Stunden nach dem Einbau, bevor Sie den Motor starten, damit sich die neue Dichtung an die Komponenten anpassen kann, um eine vollständige Dichtigkeit zu gewährleisten.

Die in dieser Publikation enthaltenen Anweisungen, Empfehlungen und Informationen wurden mit größter Sorgfalt erstellt. Marelli Aftermarket Italy S.p.A. übernimmt im Namen und im Auftrag ihrer Tochtergesellschaften keine Verantwortung für Schäden jeglicher Art, die sich auch aus einer falschen Auslegung der darin enthaltenen Informationen ergeben.

**MAGNETI
MARELLI**

PARTS & SERVICES

Véhicules du groupe VW

COMMENT IDENTIFIER LE KIT CHAÎNE DE DISTRIBUTION LE PLUS ADAPTÉ

La distribution par chaîne est de plus en plus employée sur les différents modèles du groupe VOLKSWAGEN.

L'expérience montre que ce groupe apporte généralement diverses modifications successives, aux mêmes moteurs, modifiant certains composants de distribution.

Cela rend difficile l'identification du bon schéma de distribution du moteur et, par conséquent, l'identification du kit chaîne de distribution Magneti Marelli Parts & Services adapté.

Pour minimiser les risques d'erreur dans le choix du bon kit de chaîne de distribution pour l'entretien d'un véhicule du groupe VW, nous recommandons de toujours :



Vérifier les **références OE** des principaux composants de distribution tels que : les chaînes, les tendeurs de chaîne, les engrenages...



Vérifier le **type de chaîne installée** (Simplex / Duplex / Morse...)

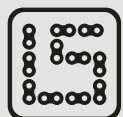

Vérifier le **nombre de maillons** des chaînes d'origine



Vérifier si un **bulletin technique** spécifique au véhicule/modèle est disponible (ex : présence du bulletin technique avec un QR code dans la boîte des kits chaîne Magneti Marelli Parts & Services)



Vérifier toutes les informations mentionnées ci-dessus avec celles des composants présents dans les différents kits chaîne de distribution Magneti Marelli Parts & Services



**MAGNETI
MARELLI**

PARTS & SERVICES

MCK0900

PROCÉDURE DE CALAGE DE LA CHAÎNE DISTRIBUTION

Constructeurs : **Audi, Volkswagen**Modèles : **Audi A3, Volkswagen EOS, Golf V, Golf Plus, Jetta III, Passat VI, Touran**Code moteur : **BAG, BLF, BLG, BLP, BMY**Puissance : **1.4 FSI, 1.4 TSI, 1.6 FSI (115, 140, 170 CV)**Pignon : **Z=18/23; OE : 03C105209AF/AG**

Précautions générales

- Toujours débrancher le câble de masse de la batterie.
- Retirez les bougies d'allumage pour permettre au moteur de tourner plus librement.
- Toujours faire tourner le moteur dans le sens normal de rotation (sauf indication contraire).
- Respectez les couples de serrage.
- Le cas échéant : notez la position du capteur de position de l'arbre moteur avant le démontage.
- **NE PAS TOURNER** l'arbre moteur en tournant l'arbre à cames ou autres pignons.
- **NE PAS TOURNER** l'arbre moteur ou l'arbre à cames lorsque la chaîne de distribution est retirée.

Procédure de calage de la chaîne de distribution

- Pour démonter/monter la chaîne de distribution, il est nécessaire de :
 - Retirer le couvercle de la distribution du moteur
 - Retirer la coupelle

! Marquez le sens de rotation sur les chaînes.

- Insérez l'horloge de mesure et son support dans le trou de la bougie d'allumage pour le cylindre n. 1. Assurez-vous que le moteur est au PMH du cylindre n. 1. **1**
- Assurez-vous que les repères de calage sur l'arbre à cames sont alignés comme illustré **2**. Sinon, tournez l'arbre moteur de 360°.
- Insérez l'outil d'alignement de l'arbre à cames. **3**

! Si l'outil d'alignement de l'arbre à cames ne peut pas être inséré, le calage de la chaîne de distribution n'est pas correct.

- Appuyez sur le tendeur de chaîne et bloquez-le avec la goupille de blocage. **4**
- Démontez le pignon d'arbre à cames et la chaîne.
- Alignez les arbres à cames. Utilisez l'outil adapté. **3**
- Montez le pignon d'arbre à cames et la chaîne de distribution.

- **Moteurs avec système de distribution à calage variable :** Mettez une nouvelle vis. Serrez la vis du dispositif de réglage de l'arbre à cames d'admission **5**. Couple de serrage : 40 Nm + 90°.

! La vis du pignon d'arbre à cames d'admission est fileté en sens inverse.

- **Moteurs sans système de distribution à calage variable :** Serrez la vis du pignon d'arbre à cames d'admission **6**. Couple de serrage : 50 Nm + 90°.

- Serrez la vis du pignon d'arbre à cames d'échappement. Couple de serrage : 50 Nm + 90°.

- Serrez la vis de poulie d'arbre moteur. Couple de serrage **7** :

- A = 150 Nm + 180°
- B = 90 Nm + 90°

! La vis de poulie d'arbre moteur et toutes les vis de pignon d'arbre à cames **DOIVENT** être utilisés une seule fois.

- Démontez l'outil d'alignement d'arbre à cames. Tournez l'arbre moteur dans le sens des aiguilles d'une montre pendant deux tours.

- Vérifiez le calage de la chaîne de distribution **3**.

Outillage spécifique

- Horloge de mesure - n. VAS 6970.
- Support d'horloge de mesure - n. T10170.
- Outil d'alignement d'arbre à cames - n. T10171.
- Outil de blocage de pignon d'arbre à cames - pompe à huile - n. T10172.
- Outil de blocage d'arbre moteur - n. T10340.
- Outil de blocage de poulie d'arbre moteur - n. 3415.
- Goupille de blocage du tendeur de chaîne - n. T40011.

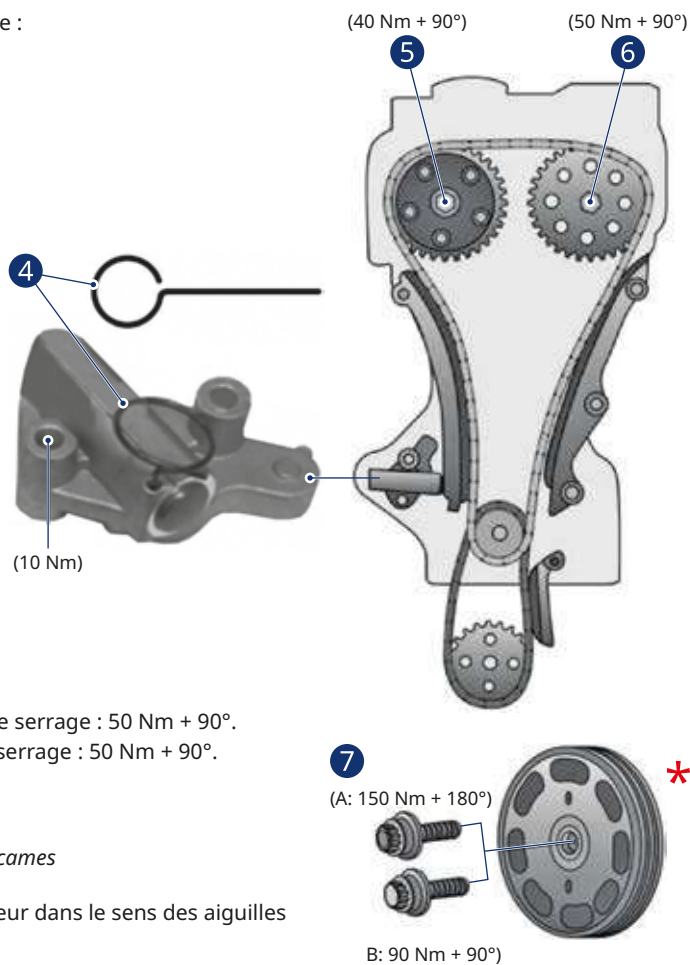
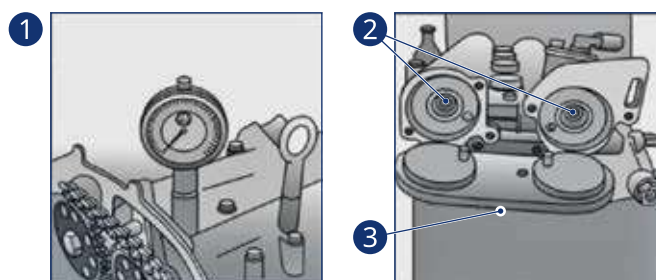

! Le tendeur de chaîne fourni dans ce kit est à ressort et peut causer des dommages s'il n'est pas manipulé correctement. **NE PAS** retirer la goupille avant qu'elle ne soit complètement installée et assurez-vous toujours que le piston est dirigé loin de vous ou de toute autre personne dans un rayon de 20 mètres.

Les instructions, les recommandations et les informations contenues dans cette publication ont été préparées avec la plus grande attention. Magneti Aftermarket Italy S.p.A., au nom et pour le compte de ses filiales, n'assume aucune responsabilité pour tout type de dommage, même dérivant d'une mauvaise interprétation des informations qui y sont contenues.

* PRÉCISION SUR LE COUPLE DE SERRAGE DES VIS

Le bulletin technique contient les informations suivantes :

- Serrez la vis de poulie d'arbre moteur.
Couple de serrage ⑦:

- A = 150 Nm + 180°
- B = 90 Nm + 90°.

Deux couples de serrage pour une seule vis. Lequel ?

A

Si, sur le véhicule est installée une **vis combinée dodécaèdre**, à tête alésée, résistance/catégorie 10.9, dimensions M14x1,5x100, OE. : N91048601 comme celle montrée ci-dessous :



Le couple de serrage maximal doit être fixé à : **150 Nm + 180°** (cas A)

B

Si, sur le véhicule est installée une vis différente « **sans tête de vis** », le couple de serrage maximal doit être fixé à : **90 Nm + 90°** (cas B)

**MAGNETI
MARELLI**

PARTS & SERVICES

Joint d'étanchéité FPM et PTFE

INSTRUCTIONS ET PRÉCAUTIONS POUR UNE BONNE INSTALLATION

Les kits chaîne Magneti Marelli Parts & Services comprennent deux types de joint d'étanchéité : le premier en **FPM** (caoutchouc fluoré) et le second en **PTFE** (polytétrafluoréthylène).

Les deux joints d'étanchéité diffèrent non seulement par le matériau dans lequel ils sont fabriqués, mais également par la méthode d'installation qui doit être suivie, tout en prenant en compte les précautions nécessaires.

Joint d'étanchéité FPM (caoutchouc fluoré)

Caractéristiques

- Ces joints d'étanchéité sont considérés comme étant de type « traditionnel »,
- Ils créent une barrière physique entre l'environnement interne (en contact avec le fluide) et l'environnement externe,
- Ils ont un ressort métallique à l'intérieur qui applique une pression sur toute la circonférence de la lèvre inférieure du joint, améliorant ainsi son étanchéité.

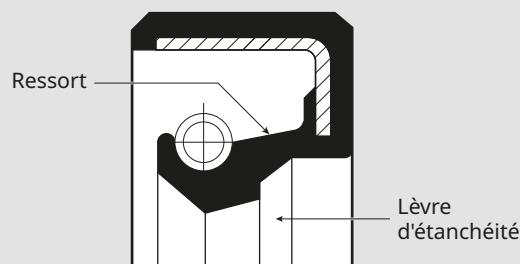

Notice d'installation

- Vérifier les informations du joint (taille et sens de rotation) et le type de matériau du joint d'étanchéité à remplacer,
- Retirer toute saleté et débris de toutes les surfaces métalliques qui entre en contact avec le joint d'étanchéité,
- **Ne pas appliquer de graisse ou de lubrifiant sur la surface extérieure du joint ou du boîtier de joint.** Si ces surfaces sont contaminées, l'étanchéité externe sera compromise dès l'installation du joint,
- **Appliquer de la graisse sur la lèvre d'étanchéité inférieure du joint et sur la surface glissante de l'arbre uniquement,**
- Mettre le joint en place avec les outils adaptés. Le côté montrant les informations du joint doit être tourné vers l'extérieur.



Le joint d'étanchéité est efficace presque immédiatement et le moteur peut être démarré après dix minutes.

Joint d'étanchéité PTFE (polytétrafluoréthylène)

Caractéristiques

Malgré l'absence de ressort métallique interne, ces joints d'étanchéité présentent les caractéristiques suivantes :

- Surface d'étanchéité en contact avec le métal plus large, offrant une étanchéité accrue,
- Amélioration de la résistance mécanique face aux contraintes, même à des vitesses de rotation élevées,
- Amélioration de la résistance chimique aux lubrifiants avec additifs,
- Meilleure résistance aux températures élevées,
- Réduction significative des fuites dues au frottement.

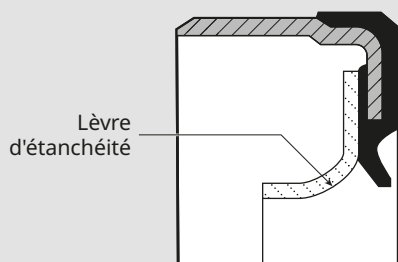

Notice d'installation



Ces joints d'étanchéité sont installés différemment des joints d'étanchéité de type « traditionnel » en FPM. La lèvre intérieure est protégée par une douille en plastique qui maintient la forme du joint et assure une parfaite adhérence à l'arbre. **La douille ne doit être retirée qu'au moment de l'installation du joint d'étanchéité.**

- Des outils spécifiques sont nécessaires pour installer le joint d'étanchéité. **Il ne faut en aucun cas endommager la lèvre intérieure du joint,**
- Le joint d'étanchéité en PTFE doit être installé à sec, sans utilisation de graisse et/ou de lubrifiant. **Ce type de joint d'étanchéité ne doit jamais être lubrifié,**
- Vérifier les informations du joint (taille et sens de rotation) et le type de matériau du joint d'étanchéité à remplacer,
- Retirer toute saleté et débris de toutes les surfaces métalliques qui entre en contact avec le joint d'étanchéité,
- Vérifier la surface de l'arbre en vous assurant qu'il est exempt de rainures ou d'autres dommages. Toute irrégularité doit être supprimée,
- Placer l'extrémité rainurée de la douille sur l'arbre. Insérer le joint d'étanchéité dans son logement en le faisant glisser le long de la douille. Une fois le joint d'étanchéité positionné dans son logement, retirer la douille.



Le joint d'étanchéité PTFE n'est pas efficace immédiatement. Il est nécessaire d'attendre jusqu'à 4 heures après le montage, avant de démarrer le moteur pour permettre au joint de s'adapter à l'arbre et d'obtenir une étanchéité totale.

Les instructions, les recommandations et les informations contenues dans cette publication ont été préparées avec la plus grande attention. Magneti Marelli Aftermarket Italy S.p.A., au nom et pour le compte de ses filiales, n'assume aucune responsabilité pour tout type de dommage, même dérivant d'une mauvaise interprétation des informations qui y sont contenues.



Vehículos del grupo VW

CÓMO IDENTIFICAR EL KIT DE CADENA DE DISTRIBUCIÓN MÁS ADECUADO

La distribución con cadena de distribución se aplica ampliamente también en varios modelos del grupo VOLKSWAGEN.

Este grupo acostumbra a realizar varias modificaciones sucesivas en los mismos motores, cambiando algunos componentes de la distribución.

Esto dificulta la identificación del esquema correcto de distribución de la cadena de distribución del motor y, por tanto, la identificación del kit de cadena de distribución Magneti Marelli Parts & Services correcto a utilizar.

Para minimizar las posibilidades de error en la elección del kit de cadena de distribución que más se ajusta para el mantenimiento de un vehículo del grupo VW, sugerimos:



Comprobar los **códigos OE** de los componentes principales de la distribución como: cadenas, tensores, engranajes...

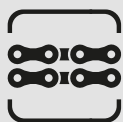

Comprobar el **tipo de cadena** instalada (Simplex / Duplex / Morse...)



Comprobar el **número de eslabones** de las cadenas OE



Comprobar y verificar la presencia de cualquier **boletín técnico** relacionado con el vehículo/modelo (ej.: código QR dentro de la caja del kit de cadena de distribución MM)



Verificar toda la información mencionada anteriormente disponible y vinculada a los componentes de un kit de cadena de distribución específico de Magneti Marelli AfterMarket Parts & Services



Las instrucciones, recomendaciones e información contenidos en esta publicación han sido preparadas con la mayor atención. Magneti Marelli Aftermarket Italy S.p.A., en su propio nombre y en el de sus filiales / subsidiarias, no asume responsabilidad por ningún tipo de daño, incluso derivado de una interpretación incorrecta de la información aquí contenida.



MCK0900

PROCEDIMIENTO DE REGULACIÓN DE LA VÁLVULA

Marcas: **Audi, Volkswagen**

Modelos: **Audi A3, Volkswagen EOS, Golf V, Golf Plus, Jetta III, Passat VI, Touran**

Códigos de motor: **BAG, BLF, BLG, BLP, BMY**

Potencia: **1.4 FSI, 1.4 TSI, 1.6 FSI (115, 140, 170 CV)**

Piñón: **Z=18/23; OE: 03C105209AF/AG**

Precauciones generales

- Desconecte siempre el cable de tierra de la batería.
- Quitar las bujías para permitir que el motor gire con mayor libertad.
- Gire siempre el motor en el sentido normal de rotación (a menos que se indique específicamente lo contrario).
- **NO** use el equipo especial mencionado anteriormente para bloquear el motor cuando el piñón o los pernos de la polea estén aflojados.
- Respete los pares de apriete.
- Si está instalado: tenga en cuenta la posición del sensor de posición del eje del motor antes de desmontarlo.
- **NO** gire el eje del motor girando el árbol de levas u otros piñones.
- **NO** gire el eje del motor o el árbol de levas sin la cadena de distribución.

Equipamiento especial

- Indicador de pantalla - n. VAS 6079.
- Soporte de indicador de pantalla - n. T10170.
- Herramienta de alineación del árbol de levas - n. T10171.
- Herramienta de bloqueo del piñón del árbol de levas - bomba de aceite - n. T10172.
- Herramienta de bloqueo del eje del motor - n. T10340.
- Herramienta de bloqueo de la polea del eje del motor - n. 3415.
- Pasador de bloqueo del tensor de cadena - n. T40011.

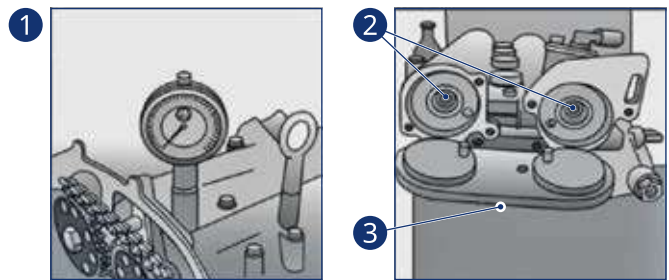

Procedimiento de sincronización de válvulas

- Para desmontar/montar la cadena de distribución es necesario:
 - Para quitar la tapa de distribución.
 - Quitar la taza.

! Marque el sentido de rotación en las cadenas.

- Colocar el manómetro y su soporte en el orificio de la bujía del cilindro n. 1. Asegúrese de que el motor esté en el PMS del cilindro n. 1 **1**.
- Asegúrese de que las marcas de distribución en el árbol de levas estén alineadas como se muestra **2**. De lo contrario, gire el eje del motor 360°.
- Montar la herramienta de alineación del árbol de levas **3**.
- **!** Si no se puede insertar la herramienta de alineación del árbol de levas, la sincronización de la válvula no es correcta.
- Presione el tensor de la cadena y bloquéelo con el pasador de bloqueo **4**.
- Desmontar el piñón del árbol de levas y la cadena.
- Alinear los árboles de levas. Utilice la herramienta especial **3**.
- Montar el piñón del árbol de levas y la cadena de distribución.

• Motores con sincronización variable de válvulas:

Coloque un perno nuevo. Apriete el perno del dispositivo de ajuste del árbol de levas de admisión **5**. Par de apriete: 40 Nm + 90°.

! El perno del piñón del árbol de levas de admisión tiene rosca inversa.

• Motores sin sincronización variable de válvulas:

Apriete el perno del piñón del árbol de levas de admisión **6**. Par de apriete: 50 Nm + 90°.

- Apretar el perno del piñón del árbol de levas de escape. Par de apriete: 50 Nm + 90°.
- Apretar el tornillo de la polea del eje del motor. Par de apriete **7**:
 - A = 150 Nm + 180°
 - B = 90 Nm + 90°.

! El perno de la polea del eje del motor y todos los pernos del piñón del árbol de levas **DEBEN** usarse una sola vez.

- Desmontar la herramienta de alineación del árbol de levas. Gire el eje del motor en el sentido de las agujas del reloj durante dos vueltas.
- Compruebe la sincronización de la válvula **3**.

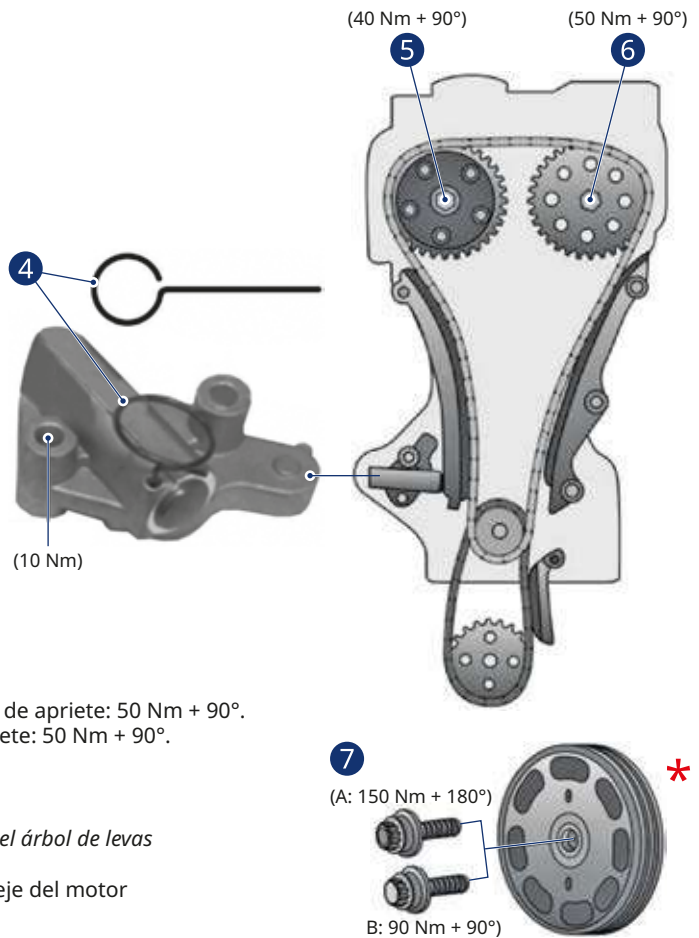

! El tensor de cadena contenido en este kit está cargado por resorte y puede causar daños si no se maneja correctamente. **NO** retire el pasador hasta que esté completamente instalado, y siempre asegúrese de que el pistón apunte lejos de usted o de cualquier otra persona dentro de un rango de 20 metros.

Las instrucciones, recomendaciones e información contenidos en esta publicación han sido preparadas con la mayor atención. Marelli Aftermarket Italy S.p.A., en su propio nombre y en el de sus filiales / subsidiarias, no asume responsabilidad por ningún tipo de daño, incluso derivado de una interpretación incorrecta de la información aquí contenida.

* ACLARACIÓN SOBRE EL PAR DE APRIETE DE TORNILLOS

En el boletín técnico se muestra la siguiente información:

- Apriete el tornillo de la polea del eje del motor.
Par de apriete ⑦:

- A = 150 Nm + 180°
- B = 90 Nm + 90°.

Dos pares de apriete para un solo tornillo. ¿Cuál?

A

Si en el vehículo se instala un tornillo **dodecaedro combinado**, con cabeza perforada, resistencia/categoría 10.9, dimensiones M14x1,5x100, OE n. : N91048601 como el que se muestra a continuación:



El par de apriete máximo debe fijarse en: **150 Nm + 180°** (Caso A)

B

Si en el vehículo se instala un tornillo diferente "**sin cabeza de tornillo**", el par de apriete máximo debe fijarse en **90 Nm + 90°** (Caso B)

**MAGNETI
MARELLI**

PARTS & SERVICES

FPM y PTFE junta de aceite

INSTRUCCIONES Y PRECAUCIONES PARA UNA CORRECTA INSTALACIÓN

Los juegos de cadenas de Magneti Marelli Parts & Services incluyen dos tipos de juntas de aceite, uno en **FPM** (caucho fluorado) y el otro en **PTFE** (Politetrafluoroetileno).

Las dos juntas de aceite se diferencian no solo por el material del que están hechos, sino también en términos del método de la instalación correcta y las precauciones relativas.

FPM (caucho fluorado) juntas de aceite

Características

- Estas juntas de aceite se consideran del tipo "tradicional".
- Crean una barrera física entre el ambiente interno, en contacto con el fluido, y el ambiente externo.
- Tienen un resorte metálico en el interior que aplica presión en toda la circunferencia del labio interior de la junta de aceite, mejorando así la estanqueidad.

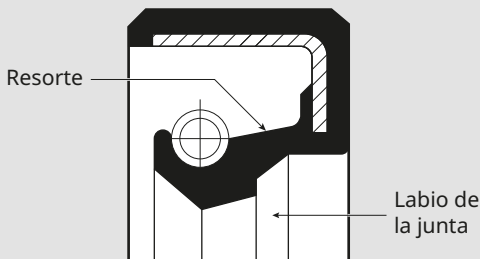

Instrucciones de instalación

- Verifique los datos de la junta (tamaño y sentido de giro) y el tipo de material del sello de aceite a reemplazar.
- Elimine la suciedad y los desechos de todas las superficies metálicas que entren en contacto con el sello de aceite.
- **No aplique grasa ni lubricantes a la superficie exterior del sello de aceite.** Si estas superficies están contaminadas, el sellado externo se verá comprometido tan pronto como sea colocado.
- **Aplique grasa en el labio de sellado interior de la junta de aceite y en la superficie de deslizamiento del eje únicamente.**
- Montar la junta en su sitio con las herramientas adecuadas. El lado que muestra los datos de la junta debe estar orientado hacia afuera.



La junta de aceite es efectiva casi de inmediato y el motor puede ser encendido después de diez minutos.

PTFE (politetrafluoroetileno) junta de aceite

Características

A pesar de la ausencia de un resorte metálico interno, estas juntas de aceite tienen las siguientes características:

- Mayor superficie de sellado en contacto con el metal, proporcionando mayor estanqueidad.
- Resistencia mecánica mejorada a la tensión incluso en altas velocidades de rotación.
- Resistencia química mejorada a lubricantes con aditivos.
- Resistencia mejorada a las altas temperaturas.
- Reducción significativa de fugas por fricción.

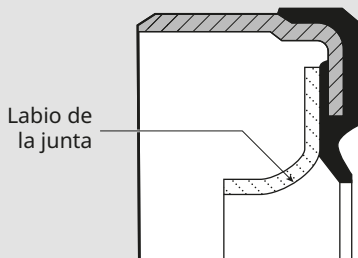

Instrucciones de instalación



Estas juntas de aceite se instalan de manera diferente a las "tradicionales" en FPM; el labio interior está protegido por un manguito de plástico que mantiene la forma de la junta y asegura una perfecta adherencia al eje. **El manguito solo se debe quitar al instalar la junta de aceite.**

- Se requieren herramientas específicas para instalar la junta de aceite. **No dañe el labio interior de la junta de ninguna manera.**
- La junta de aceite de PTFE debe instalarse en seco, sin el uso de grasa y/o lubricantes. **Esta junta nunca debe lubricarse.**
- Verifique los datos de la junta (tamaño y sentido de giro) y el tipo de material de la junta de aceite a reemplazar.
- Elimine la suciedad y los desechos de todas las superficies metálicas que entren en contacto con la junta de aceite.
- Verifique la superficie del eje, asegurándose de que esté libre de ranuras u otros daños. Deben eliminarse todas las irregularidades.
- Coloque el extremo ranurado del manguito en el eje. Inserte la junta de aceite en su alojamiento deslizando a lo largo del manguito. Una vez que la junta se haya colocado en su alojamiento, retire el manguito.



La junta de aceite de PTFE no es efectiva de inmediato. Deje transcurrir hasta cuatro horas después del montaje antes de arrancar el motor para permitir que la junta se adapte al eje y logre un ajuste total.

Las instrucciones, recomendaciones e información contenidos en esta publicación han sido preparadas con la mayor atención. Magneti Marelli Aftermarket Italy S.p.A., en su propio nombre y en el de sus filiales / subsidiarias, no asume responsabilidad por ningún tipo de daño, incluso derivado de una interpretación incorrecta de la información aquí contenida.



VW grubu araçlar

DOĞRU ZİNCİRİ KİTİ NASIL BELİRLENİR?

Zincir tahrikli motorlar, çeşitli VOLKSWAGEN grup modellerinde de yaygın olarak kullanılmaktadır.

Bu grubun aynı motorlarında da çeşitli değişiklikler yapılarak ve bazı bileşenlerin değiştirilerek kullanıldığı gözlemlenmiştir.

Bu, doğru zincir kitinin belirlenmesinde zorluklar çıkarmaktadır.

VW grubu bir aracın zinciri kitinin seçiminde hata olasılığını en aza indirmek için şunları öneriyoruz:



Zincirler, gergiler, dişliler gibi zamanlama ana bileşenlerinin **OE kodlarını** kontrol ediniz

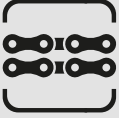

Zincir kiti türünü tespit ediniz.
(Tek Yönlü / Çift Yönlü / Mors...)

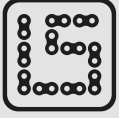

OE **zincirler kiti numarasını** kontrol ediniz



Araç/modelle ilgili herhangi bir **Teknik bültenin** varlığını kontrol edin ve doğrulayın (ör.: MM zinciri kiti kutusunun içindeki QR kodu)



Belirli bir Magneti Marelli AfterMarket Parça ve Servis zinciri kitinin bileşenlerine bağlı ve mevcut olanlarla yukarıda belirtilen tüm bilgileri doğrulayın



**MAGNETI
MARELLI**

PARTS & SERVICES

MCK0900

SUPAP ZAMANLAMASI PROSEDÜRÜ

Araç markaları: **Audi, Volkswagen**

Modeller: **Audi A3, Volkswagen EOS, Golf V, Golf Plus, Jetta III, Passat VI, Touran**

Motor kodu: **BAG, BLF, BLG, BLP, BMY**

Güç: **1.4 FSI, 1.4 TSI, 1.6 FSI (115, 140, 170 CV)**

Zincir dişlisi çarkı: **Z=18/23; OE: 03C105209AF/AG**

Genel önlemler

- Daima şasi kablosunu aküden ayırın.
- Motorun daha rahat dönmesi için bujileri sökün.
- Motoru her zaman normal dönme yönünde çevirin (aksi belirtilmedikçe).
- Sıkma torklarına dikkat edin.
- Takılmışsa: sökmeden önce motor mili konum sensörünün konumunu not edin.
- Eksantrik milini veya diğer pinyon dişlileri çevirerek motor milini çevirmeye **ÇALIŞMAYIN**.
- Triger zinciri sökülmüş iken motor milini veya eksantrik milini **ÇEVİRMEYİN**.

Supap zamanlaması prosedürü

- Triger zincirini sökmek/takmak için, şunları yapmak gerekir:
 - Triger zinciri muhafazası kapağını çıkarın.
 - Fincanı çıkarın.

! Zincirlerin dönme yönünü not edin.

- Ölçme aletini ve desteğini 1 No'lu silindirin buji deliğine yerleştirin. Motorun 1 No'lu silindirin üst ölü noktasında (ÜÖN) olduğundan emin olun **1**.

- Eksantrik mili üzerindeki zamanlama işaretlerinin gösterildiği gibi hizalandığından emin olun **2**. Aksi halde, motor milini 360° çevirin.

- Eksantrik mili hizalama aletini takın **3**.

! Eksantrik mili hizalama aleti takılamıyorsa, supap zamanlaması doğru değildir.

- Zincir gergisini bastırın ve kilitleme pimi ile bloke edin **4**.

- Eksantrik mili pinyon dişlisini ve zinciri sökün.

- Eksantrik millerini hizalayın. Özel aleti kullanın **5**.

- Eksantrik mili pinyon dişlisini ve triger zincirini takın.

• Değişken supap zamanlamalı motorlar:

Yeni bir civata takın. Emme eksantrik mili ayar cihazı civatasını sıkın **5**. Sıkma torku: 40 Nm + 90°.

! Emme eksantrik mili pinyon dişlisi civatası ters dişlidir.

• Değişken supap zamanlamalı olmayan motorlar:

Emme eksantrik mili pinyon dişlisi civatasını sıkın **6**. Sıkma torku: 50 Nm + 90°.

- Egzoz eksantrik mili pinyon dişlisi civatasını sıkın. Sıkma torku: 50 Nm + 90°.

- Motor mili kasnağı civatasını sıkın. Sıkma torku **7**:

- A = 150 Nm + 180°
- B = 90 Nm + 90°.

! Motor mili kasnak civatası ve tüm eksantrik mili pinyon dişli civataları yalnızca bir kez **KULLANILMALIDIR**.

- Eksantrik mili hizalama aletini çıkarın. Motor milini saat yönünde iki tur döndürün.

- Subap zamanlamasını kontrol edin **3**.

Özel ekipman

- Ölçme aleti - No. VAS 6079.
- Ölçme aleti desteği - No. T10170.
- Eksantrik mili hizalama aleti - No. T10171.
- Eksantrik mili pinyon dişlisi - yağ pompası tutma aleti - No. T10172.
- Motor mili tutma aleti - No. T10340.
- Motor mili kasnağı tutma aleti - No. 3415.
- Zincir gergisi kilitleme pimi - No. T40011.

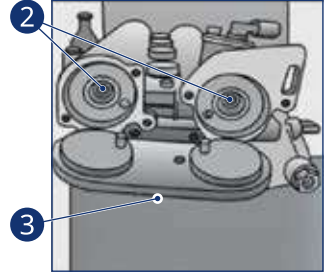
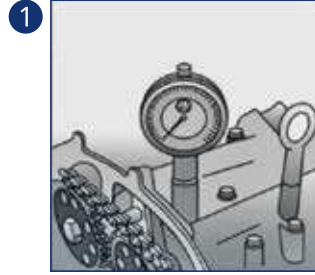

(40 Nm + 90°) (50 Nm + 90°)

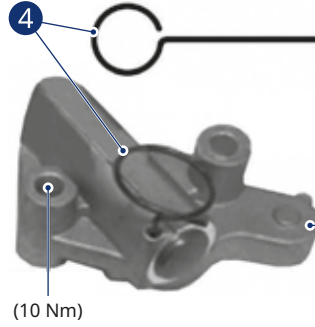
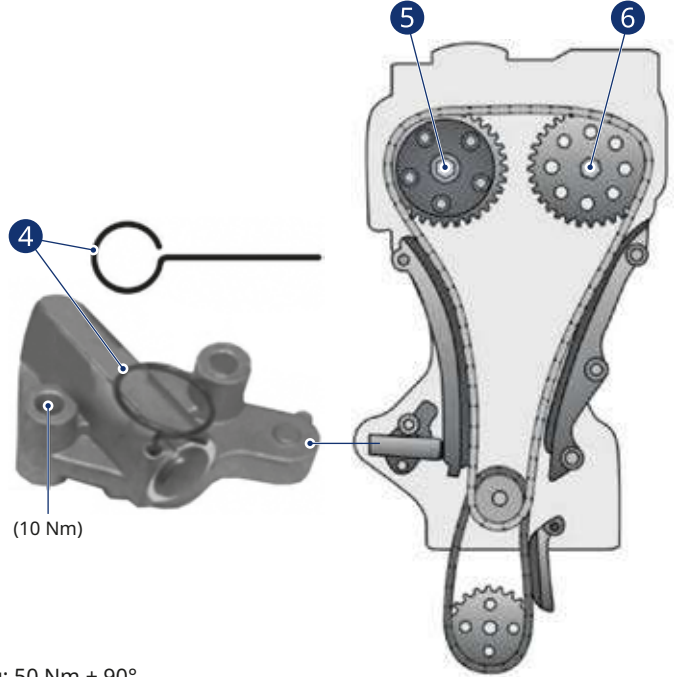

(10 Nm)

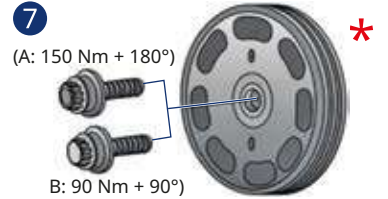

(A: 150 Nm + 180°)

(B: 90 Nm + 90°)

*

! Bu kittede bulunan zincir gergisi yaylıdır ve düzgün kullanılmazsa hasara yol açabilir. Tamamen oturmadan pimi **ÇIKARMAYIN** ve pistonun daima sizden veya 20 metrelik bir menzil içindeki diğer insanlardan uzağa doğru baktığından emin olun.

Bu yayında yer alan talimatlar, tavsiyeler ve bilgiler büyük bir titizlikle hazırlanmıştır.

Marelli Aftermarket Italy S.p.A., bağlı şirketleri/yan kuruluşları adına ve namına, burada yer alan bilgilerin yanlış yorumlanmasından kaynaklanan hasarlardan dolayı herhangi bir sorumluluk kabul etmez.

* VİDA SIKMA TORKU İLE İLGİLİ AÇIKLAMA

Teknik bültende aşağıdaki bilgiler verilmiştir:

- Motor mili kasnağı civatasını sıkın.
Sıkma torku **7**:

- A = 150 Nm + 180°
- B = 90 Nm + 90°.

Tek bir vida için iki sıkma torku var. Hangisi?

A Araca, aşağıda gösterildiği gibi, oyuk başlı, 10.9 dirençli/ kategorili, M14x1,5x100 boyutlu, N91048601 parça numaralı **kombine on iki köşeli bir vida** takılıysa:



Maksimum sıkma torku: **150 Nm + 180°** (Durum A)

B Araca "**vida başı olmayan**" farklı bir vida takılmışsa, maksimum sıkma torku **90 Nm + 90°** olmalıdır (Durum B).

**MAGNETI
MARELLI**

PARTS & SERVICES

FPM ve PTFE yağ keçeleri

DOĞRU TAKMA YÖNTEMİNE YÖNELİK TALİMATLAR VE ÖNLEMLER

Magneti Marelli Parts & Services zincir kitleri, biri **FPM** (florlu kauçuk) ve diğeri **PTFE** (Politetraflüoroetilen) olmak üzere iki tip yağ keçesi içermektedir.

İki yağ keçesi sadece imal edildikleri malzeme açısından değil, aynı zamanda doğru takma yöntemi ve ilgili önlemler bakımının da farklılık gösterir.

FPM (florlu kauçuk) yağ keçeleri

Özellikleri

- Bu yağ keçeleri "geleneksel" tip olarak kabul edilir.
- Yağ ile temas halindeki iç ortam ile dış ortam arasında fiziksel bir bariyer oluştururlar.
- İç yağ keçesi dudağının tüm çevresine basınç uygulayan ve böylece sızdırmazlığı daha iyi hale getiren metal bir yayları vardır.

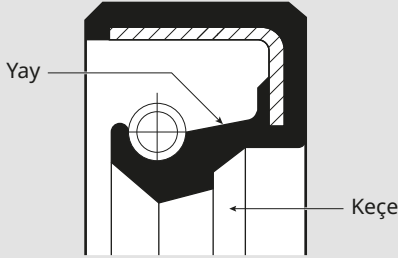

Takma talimatları

- Keçe verilerini (boyut ve dönme yönü) ve değiştirilecek yağ keçesi malzemesinin tipini kontrol edin.
- Yağ keçesine temas eden tüm metal yüzeylerdeki kir ve kalıntıları temizleyin.
- **Yağ keçesinin veya keçe muhafazasının dış yüzeyine gres veya yağ sürmeyin.** Bu yüzeyler kirlenirse, keçe takıldığında dış sızdırmazlık olumsuz etkilendir.
- **Yağ keçesinin iç sızdırmazlık dudağına ve sadece milin kayma yüzeyine gres sürün.**
- Uygun aletler kullanarak keçeyi yerine oturtun. Keçe verilerini gösteren taraf dışarı doğru bakmalıdır.



Yağ keçesi hemen etkili olmaya başlar ve motor 10 dakika sonra çalıştırılabilir.

PTFE (politetraflüoroetilen) yağ keçesi

Özellikleri

Dahili bir metal yayı olmayan bu yağ keçelerinin aşağıdaki özellikleri vardır:

- Metal ile temas halinde olan geniş sızdırmazlık yüzeyi, daha iyi sızdırmazlık sağlar.
- Yüksek dönme hızlarında bile gerilime karşı yüksek mekanik direnç.
- Katkı maddeli yağlara karşı geliştirilmiş kimyasal direnç.
- Yüksek sıcaklıklara karşı yüksek direnç.
- Sürtünmeden kaynaklı kaçaklarda önemli azalma.

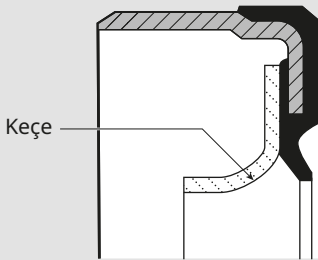

Takma talimatları



Bu yağ keçeleri FPM tipi "geleneksel" yağ keçelerinden farklı şekilde takılır; iç dudak, keçenin şeklini koruyan ve mile mükemmel bir şekilde yapışmasını sağlayan plastik bir manşonla korunmaktadır. **Manşon yalnızca yağ keçesi takıldığı zaman çıkarılmalıdır.**

- Yağ keçesini takmak için özel aletler gereklidir. **Keçenin iç dudağına hiçbir şekilde zarar vermeyin.**
- PTFE yağ keçesi, gres ve/veya yağ kullanılmadan kuru şekilde takılmalıdır. **Bu tip yağ keçesi asla yağlanmamalıdır.**
- Keçe verilerini (boyut ve dönme yönü) ve değiştirilecek yağ keçesi malzemesinin tipini kontrol edin.
- Yağ keçesine temas eden tüm metal yüzeylerdeki kir ve kalıntıları temizleyin.
- Milin yüzeyini kontrol edin ve çizik veya başka hasarlar olmadığından emin olun Düzensizlikler giderilmelidir.
- Manşonun oluklu ucunu milin üzerine yerleştirin. Yağ keçesini, manşon boyunca kaydırarak yuvasına yerleştirin. Yağ keçesi yuvasına yerleştirildikten sonra manşonu çıkartın.



PTFE yağ keçesi hemen etkili olmaz. Keçenin mile alışması ve tam sızdırmazlık sağlaması için, keçeyi taktıktan sonra motoru çalıştırmadan dört saate kadar bekleyin.

Bu yayında yer alan talimatlar, tavsiyeler ve bilgiler büyük bir titizlikle hazırlanmıştır.

Marelli Aftermarket Italy S.p.A., bağlı şirketleri/yan kuruluşları adına ve namına, burada yer alan bilgilerin yanlış yorumlanmasından kaynaklanan hasarlardan dolayı herhangi bir sorumluluk kabul etmez.